

# TenaControls LLC

Milford, MA 01757 U.S.A.  
[www.TenaControls.com](http://www.TenaControls.com)

*TenaControls Brings Models to Life*

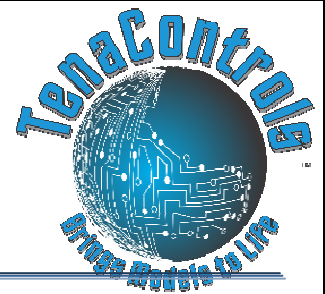

## - INSTRUCTIONS -

### 1001-EE NAVIGATION BOARD FOR STAR TREK ENTERPRISE E MODEL

This unit comes completely assembled and tested. The only thing you need to do is connect the LED's and the resistors. Then, plug in a 9 volt battery and throw the switch on. Hot glue on the four corners of the printed circuit to ensure the board is secured.

#### ITEMS YOU WILL NEED:

Soldering Iron  
Solder  
Cutter  
Wire Stripper

**\*\*Note:** When using the shrink tubing, you need to only slide the shrink tubing over one leg of the LED to keep it from shorting against the other leg. Then use a heat gun or flame from lighter to heat the shrink tubing until it shrinks around the wire connected to one of the LED legs.

How to distinguish an LED:

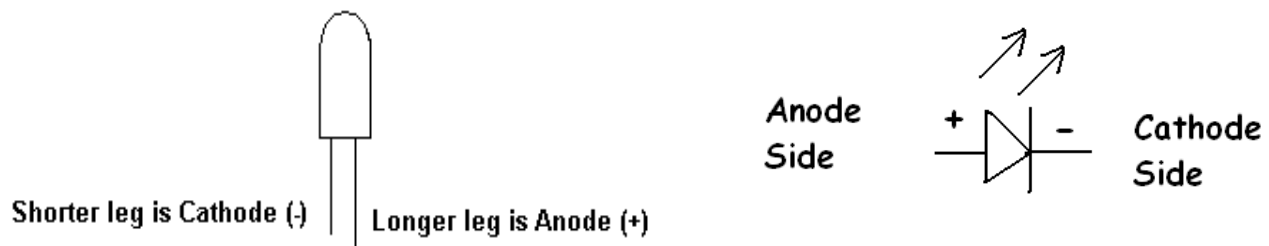

# TenaControls LLC

Milford, MA 01757 U.S.A.

[www.TenaControls.com](http://www.TenaControls.com)

*TenaControls Brings Models to Life*

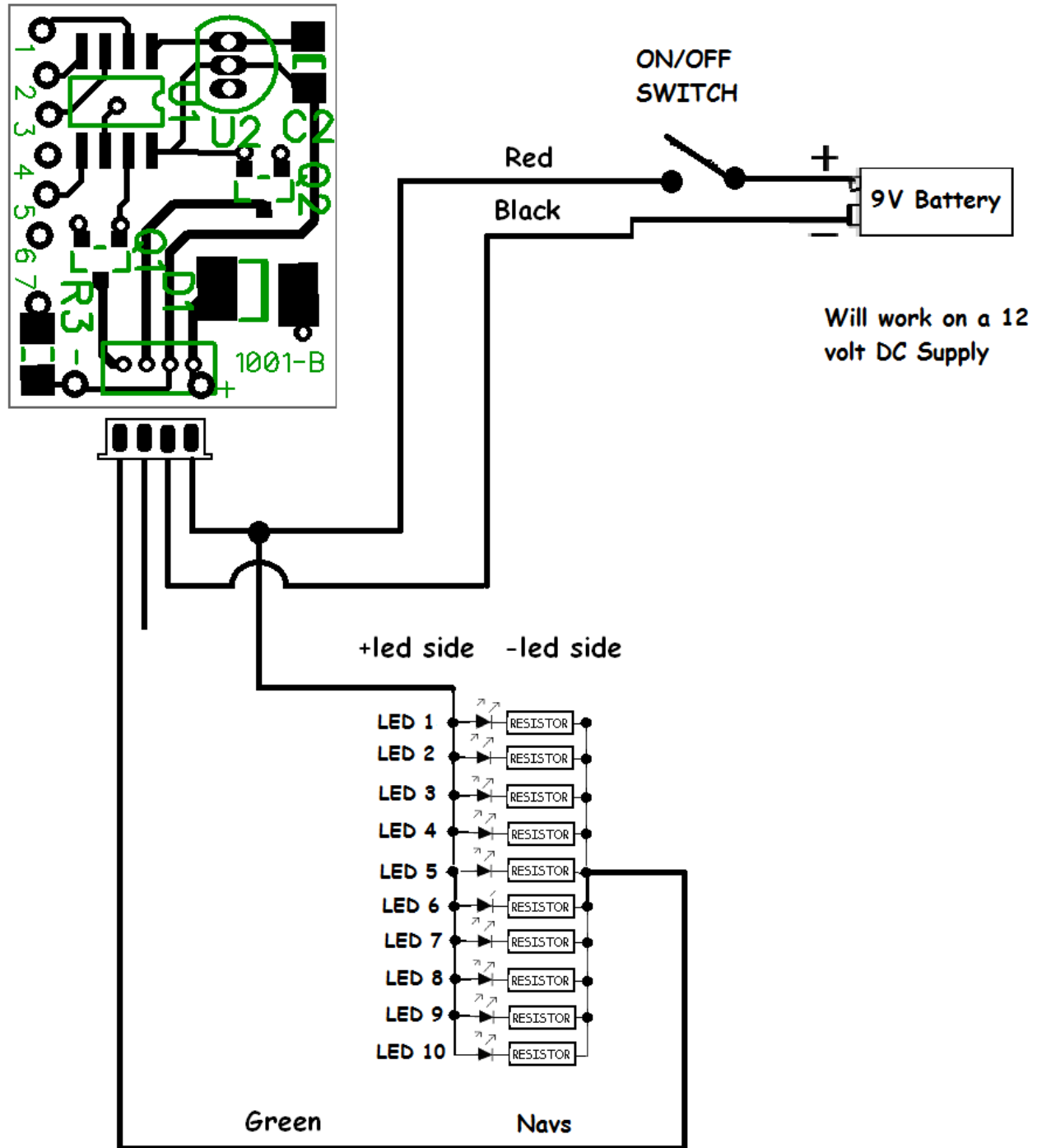
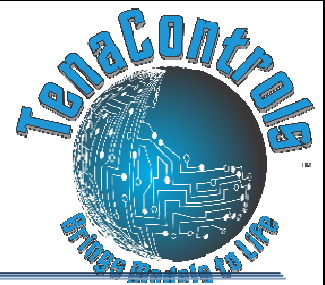

# TenaControls LLC

Milford, MA 01757 U.S.A.

[www.TenaControls.com](http://www.TenaControls.com)

*TenaControls Brings Models to Life*

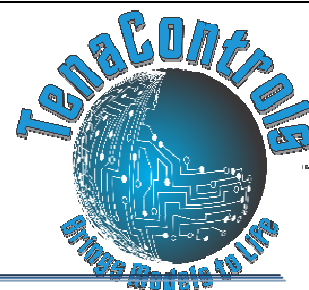

## NAVIGATION SIDE:

### 1. Six White LED's: LED2, LED4, LED5, LED9 and LED10

All the six anodes (+) of the Navigation LED's, LED2, LED4, LED5, LED9 and LED10 connect to red wire of the 4 pin connector. Then, connect the cathode (-) of LED2, LED4, LED5, LED9 and LED10, to one end of their respective resistor and the other end of resistor will terminate to the Green wire of the 4 pin connector. **See above diagram (pg. 2).**

### 2. Two Green LED's: LED3 and LED6

The two anodes (+) of the Navigation LED's, LED3 and LED6 connect to red wire of the 4 pin connector. Then, connect the cathode (-) of LED3 and LED6, to one end of their respective resistor and the other end of resistor will terminate to the green wire of the 4 pin connector. **See above diagram (pg. 2).**

### 3. Two Red LED's: LED1 and LED7

The two anodes (+) of the Navigation LED's, LED1 and LED7 connect to red wire of the 4 pin connector. Then, connect the cathode (-) of LED1 and LED7, to one end of their respective resistor and the other end of resistor will terminate to the Green wire of the 4 pin connector. **See above diagram (pg. 2).**

### 4. Place the Navigation LED's in the locations shown on the LED Locations drawings below.

# TenaControls LLC

Milford, MA 01757 U.S.A.

[www.TenaControls.com](http://www.TenaControls.com)

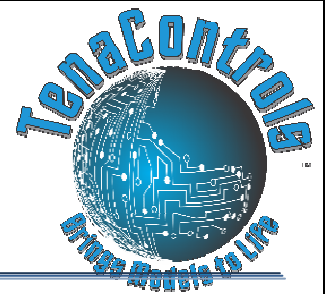

*TenaControls Brings Models to Life*

## TOP VIEW OF LED LOCATIONS:

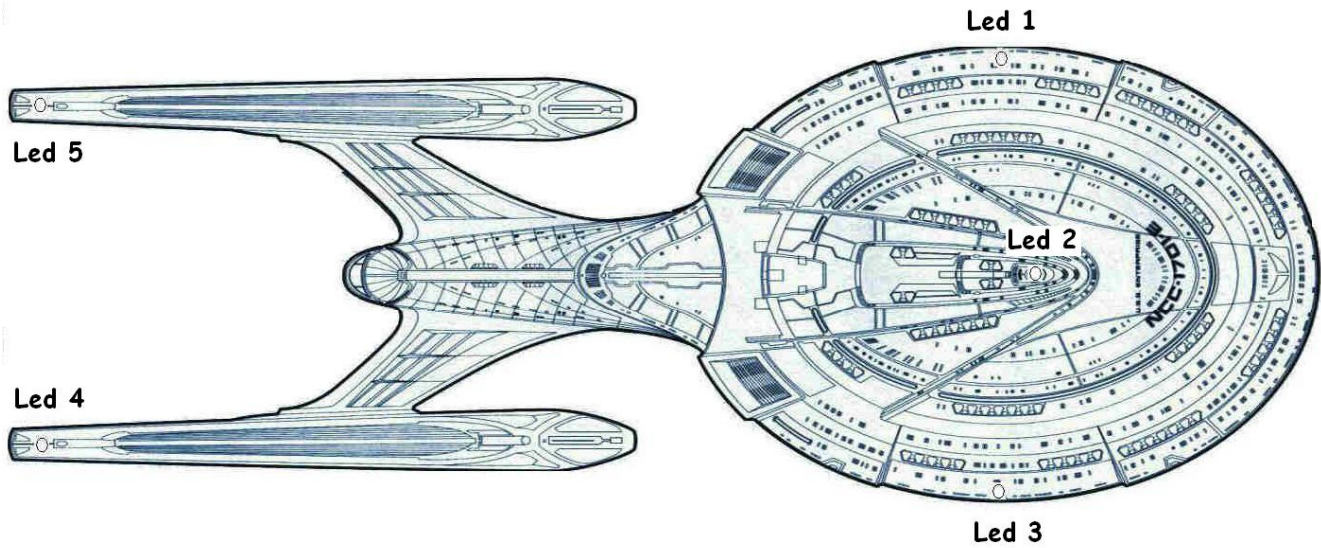

# TenaControls LLC

Milford, MA 01757 U.S.A.  
[www.TenaControls.com](http://www.TenaControls.com)

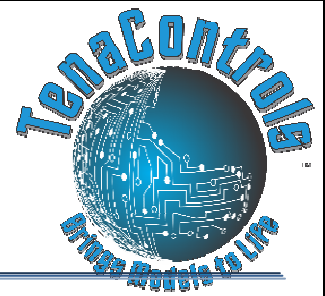

*TenaControls Brings Models to Life*

## BOTTOM VIEW OF LED LOCATIONS:

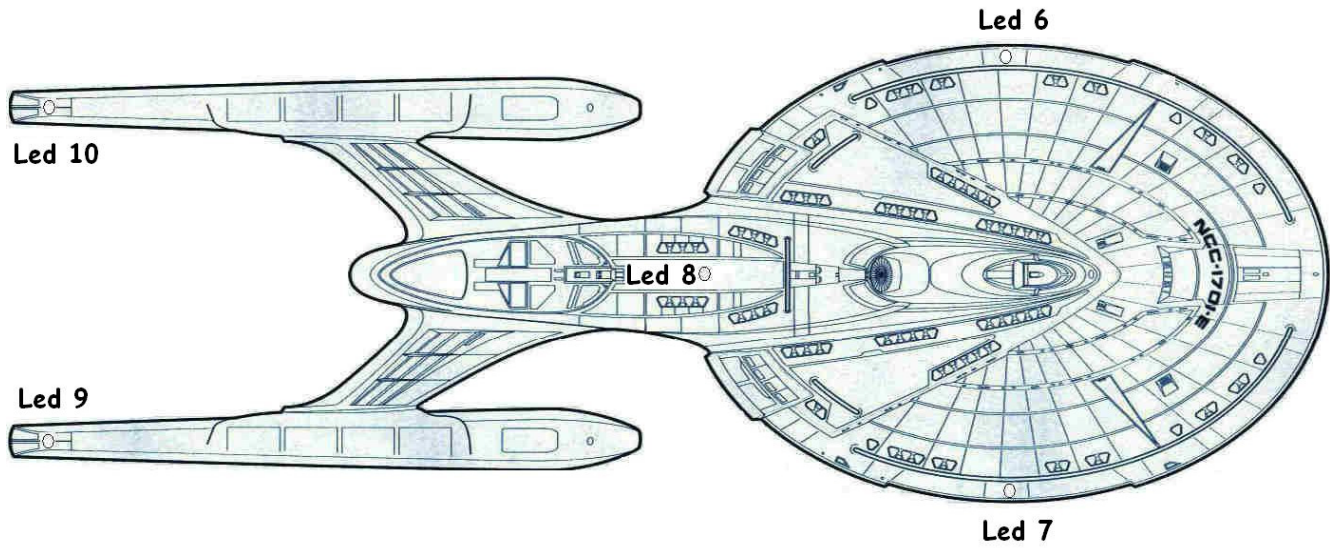

# TenaControls LLC

Milford, MA 01757 U.S.A.

[www.TenaControls.com](http://www.TenaControls.com)

*TenaControls Brings Models to Life*

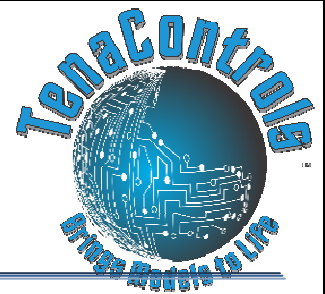

## Warranty

TenaControls LLC warrants that the control boards sold meet TenaControls LLC specifications and are adequately contained, packaged and labeled and conform to the promises and affirmations of fact made on the container and label. THE FOREGOING WARRANTIES ARE EXCLUSIVE, AND ARE IN LIEU OF ALL OTHER WARRANTIES (WHETHER WRITTEN, ORAL OR IMPLIED) INCLUDING WARRANTY OR MERCHANTABILITY IN OTHER RESPECTS THAN EXPRESSLY SET FORTH ABOVE AND WARRANTY OF FITNESS FOR A PARTICULAR PURPOSE.

In the event that there is a breach of express warranty by the manufacturer made in connection with the purchase of this product, if any, the sole remedy of any buyer shall be to return the product along with original sales receipt, at **buyer's expense** for repair (or replacement of the product if repair is impossible) to the manufacturer's facility in the Commonwealth of Massachusetts, located at 22 Hancock Street, Milford, MA 01757. Some states do not allow the exclusion or limitation of any incidental or consequential damages, so the above limitation may not apply to you. Nothing herein contained shall be construed to be a waiver by the manufacturer of any of the obligations imposed upon said buyer under the laws of the Commonwealth of Massachusetts except as herein specifically stated.

This warranty is enforceable only by the buyer of the product or a person in the buyer's immediate family. This warranty is enforceable for a period of **FIVE YEARS** from the date of purchase. Some states do not allow limitations on how long an implied warranty lasts, so the above warranty may not apply to you. This warranty gives you specific legal rights and you may also have other rights which vary from state to state.

### Warranty Void if:

- A) Product is altered in any way.
- B) Used for other than its intended use.
- C) Buyer mishandling.